

# CRAFT + MAIN

CABINETS







## ABOUT US

Craft + Main Cabinetry has over 30 years of experience in cabinet manufacturing, with a dedicated team of design professionals, artisans, and wood crafting experts. We pride ourselves in constructing high quality and stylish custom cabinetry, to build strong and beautiful kitchens that last a lifetime.

Our state-of-the-art manufacturing facility allows us to create cabinetry that is entirely custom, built to your unique style and needs. By using the finest North American hardwoods for all of our door and drawer fronts, we're able to ensure that your cabinetry is the best it can be.



Photos Courtesy of HGTV Canada



# *Endless Possibilities*

8 WOOD SPECIES

17 GLAZE OPTIONS

9 WOOD GRADES

17 SHEEN OPTIONS

10 DOOR STYLES

19 STILE & RAIL WIDTHS

12 ENAMEL FINISHES

19 EDGE PROFILES

14 STAIN FINISHES

22 CONSTRUCTION OPTIONS

16 PREMIUM FINISHES







# WOOD SPECIES



ALDER

A medium density hardwood with a fine, moderate grain pattern. Pin knots and pin knot clusters are common in this species.



CHERRY

An elegant, multi-colored hardwood, which may contain small knots, pinholes and pitch pockets. Natural or light stains accent these color variations making a distinctive statement in a full kitchen.



WALNUT

An elegant, multi-colored hardwood, which may contain small knots and pinholes which natural or light stains accent.



MAPLE

A strong, close-grained wood that is predominantly off-white in color and occasionally contains light tan or small dark mineral streaks.



POPLAR

A medium density hardwood with a fine, moderate grain pattern, Sapwood color is a white, creamy yellow to green.



RED OAK

A strong, open-grained wood that has a range in color of white, yellow and pink. Pin knots are common in this species.



HICKORY

A strong, open-grained wood that has a range in color of white, yellow and brown. Pin knots are found in this species.



WHITE OAK

A strong, open-grained wood that has a range in color of whitish brown to grayish brown. Pin knots can be common in this species.



# WOOD GRADES



PAINT

Paint or budget wood grade allows for many variations in the wood. This is the perfect choice for an enamel finish or for dramatic color variations with natural or light stains.



RUSTIC

Rustic wood grade allows for an abundance of character exemplified by dramatic color variation and textural interest. Mineral, heartwood, and knots are common in this grade.



NATURAL

Natural wood grade is great for staining and painting. With its high quality, no matter which finish you choose, your cabinets will look beautiful. Minor imperfections inherent to natural wood may be present.



SELECT

Select is the highest quality of wood that we offer. It's popular for having the least number of imperfections, with carefully selected, color matched staves, it's highly recommended for natural finishes.

# DOOR STYLES

Craft + Main Cabinetry door styles are available in any of our eight North American hardwood species. Many can be customized even further by changing the stile & rail width and the edge profile.

25  
DOOR STYLES  
TO  
CHOOSE FROM



BRADFORD

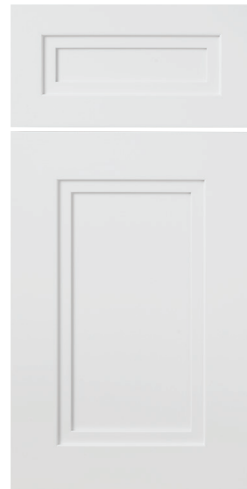

COLORADO



DAVIDSON



DEERFIELD



DELAWARE

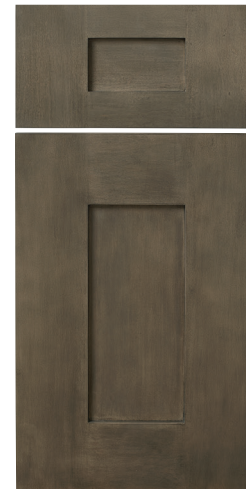

FARMINGTON



JEFFERSON



NOBLE



RARITAN

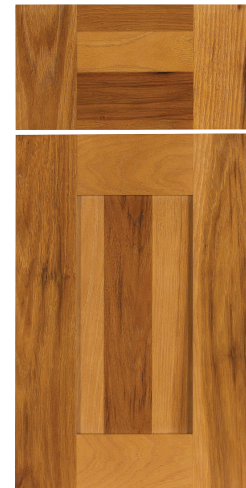

SACRAMENTO



SENECA

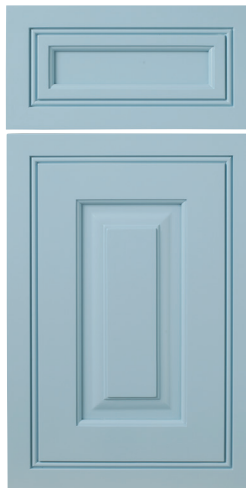

THOMPSON



GALLATIN

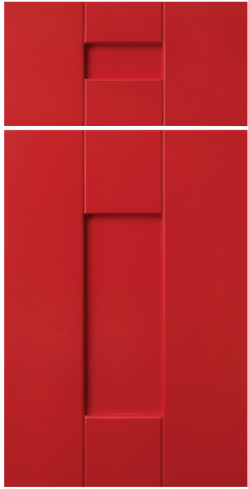

GLENWOOD



HANOVER



HOLSTON



HUDSON

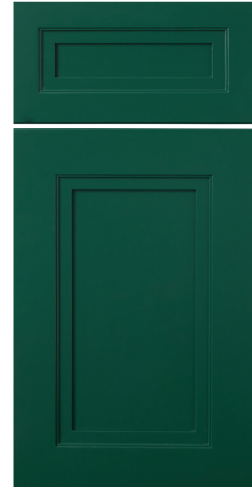

JACKSON



WILLIAMSON

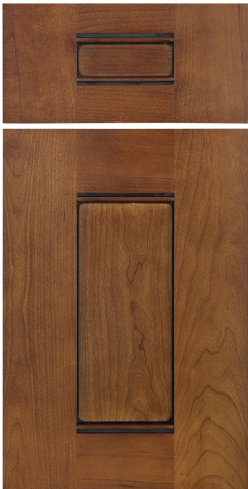

KENNEBEC



MADISON



MADISON ARCH



MARQUETTE

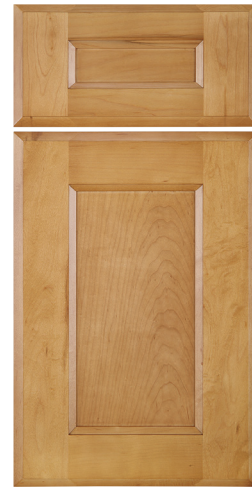

MISSOURI



NESHANIC

# ENAMELS

Craft and Main Cabinetry offers a selection of premium enamel finishes. Each colour is carefully chosen by our design team based upon current and upcoming design trends.

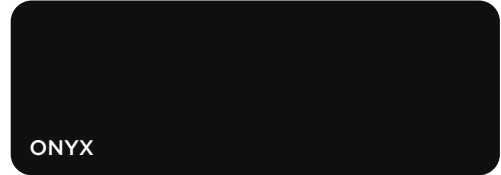
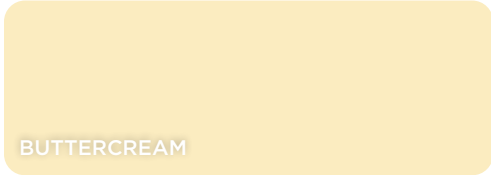
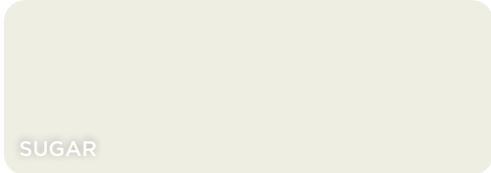
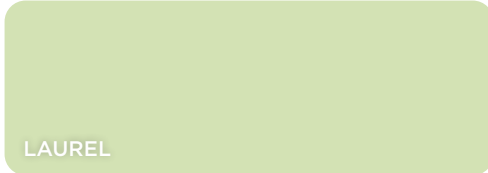
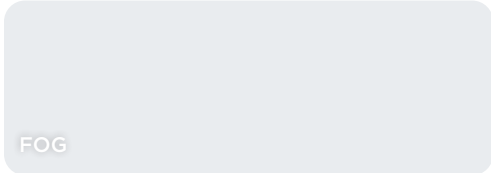
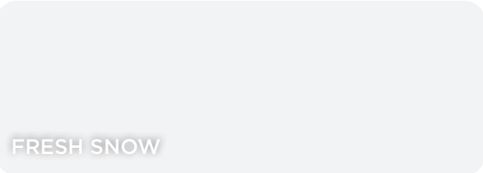



# CUSTOM COLOURS

Craft and Main Cabinetry offers color matching using X-Rite Color Management technology to create the perfect custom colour you've been searching for. Create a one-of-a-kind colour palette for your enamel kitchen cabinets. Simply provide a colour code from either Benjamin Moore or Sherwin Williams, and we will provide you with a sample door for your approval.

# STAINS

Craft + Main Cabinetry offers a selection of premium stain finishes. Each colour is carefully chosen by our team of designers based upon current and upcoming design trends.

A rectangular sample of wood stained in a dark, rich brown color with a subtle vertical grain pattern.

SABLE

A rectangular sample of wood stained in a very dark, almost black color with a vertical grain pattern.

GARNET

A rectangular sample of wood stained in a medium-dark brown color with a vertical grain pattern.

OYSTER

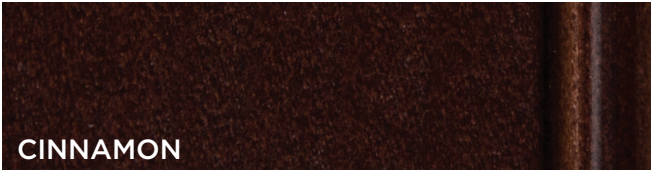
A rectangular sample of wood stained in a deep, dark brown color with a vertical grain pattern.

CINNAMON

A rectangular sample of wood stained in a warm, medium brown color with a vertical grain pattern.

COLONIAL

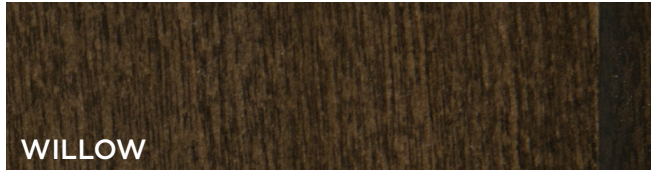
A rectangular sample of wood stained in a dark brown color with a vertical grain pattern.

WILLOW

A rectangular sample of wood stained in a warm, medium brown color with a vertical grain pattern.

SPICE

A rectangular sample of wood stained in a very dark, almost black color with a vertical grain pattern.

DARK ROAST

A rectangular sample of wood stained in a dark, muted brown color with a vertical grain pattern.

TRUFFLE

A rectangular sample of wood stained in a warm, medium brown color with a vertical grain pattern.

PURITAN

A rectangular sample of wood stained in a dark brown color with a vertical grain pattern.

GANACHE

A rectangular sample of wood stained in a dark, muted brown color with a vertical grain pattern.

DAPPLE

A rectangular sample of wood stained in a dark brown color with a vertical grain pattern.

NUTMEG

A rectangular sample of wood stained in a dark brown color with a vertical grain pattern.

WREN

A rectangular sample of wood stained in a warm, medium brown color with a vertical grain pattern.

NATURAL



# PREMIUM FINISHES

Take your cabinetry a step beyond ordinary with a hand applied premium finish. Each Craft + Main Cabinetry premium finish will accentuate the intricate craftsmanship, enhance the natural qualities of your selected wood species and further refine which details of your cabinetry come to the forefront of your design. Plus, four glaze colours are available.

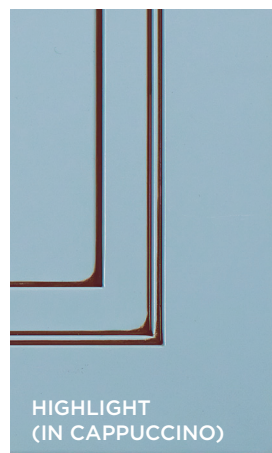



COTTON

NICKEL

## GLAZE COLOURS

Craft + Main Cabinetry offers four glaze colour options. Each colour is carefully selected to enhance each enamel and stain. Choose one of these premium glaze options for your highlight, brush, or glaze premium finish.

CAPPUCCINO

JET

Our three standard options for sheen help to maximize the beauty of your cabinetry, choose 10°, 20°, and 30°.





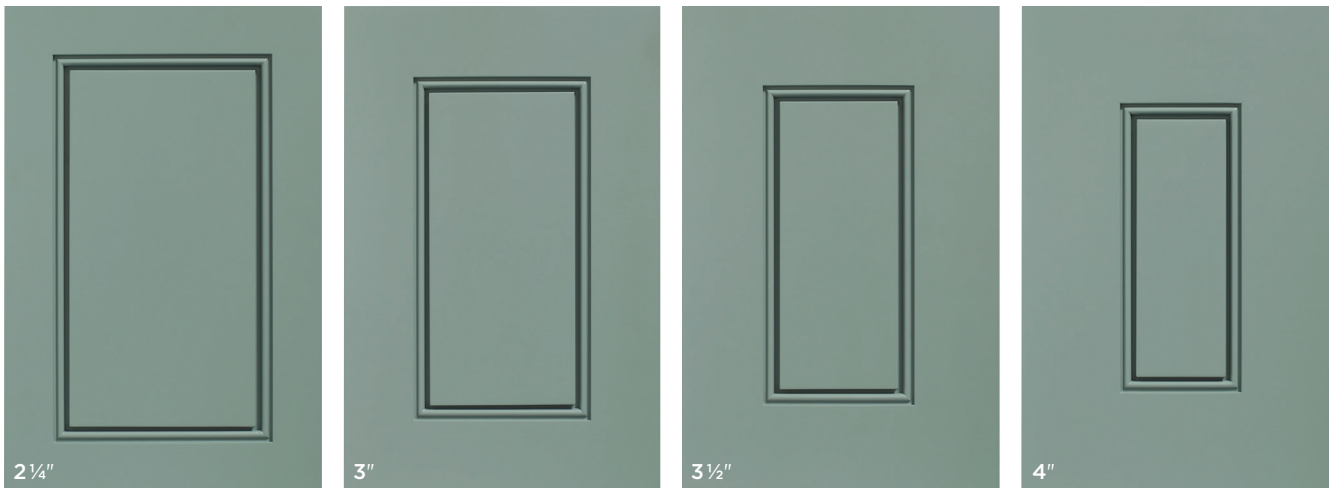

## STILE & RAIL

You can change the stile & rail width of our door styles to embrace your own style. Choose a smaller width for a classic look or a larger width for a bold statement.

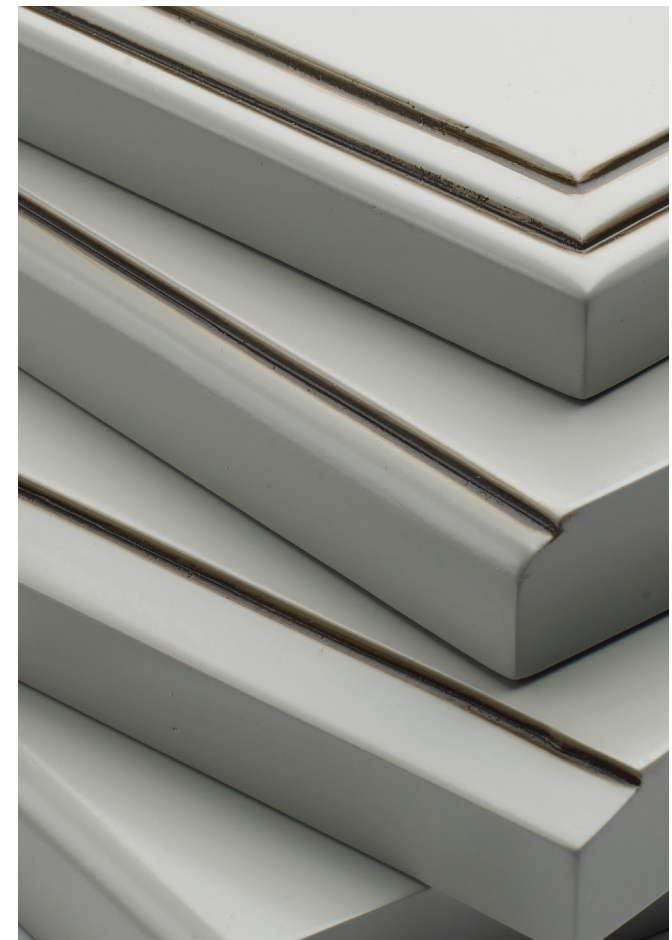

## EDGE PROFILE

To make your cabinetry one of a kind, we offer eight different edge profiles, to allow you to create a truly custom look for your home.\*

\*Due to the unique design of the following doors, Davidson, Deerfield, Delaware, Hanover, and Marquette, there are no outside edge profiles available for these door styles.

# TRULY CUSTOM

If You Can Dream It, We Can Make It



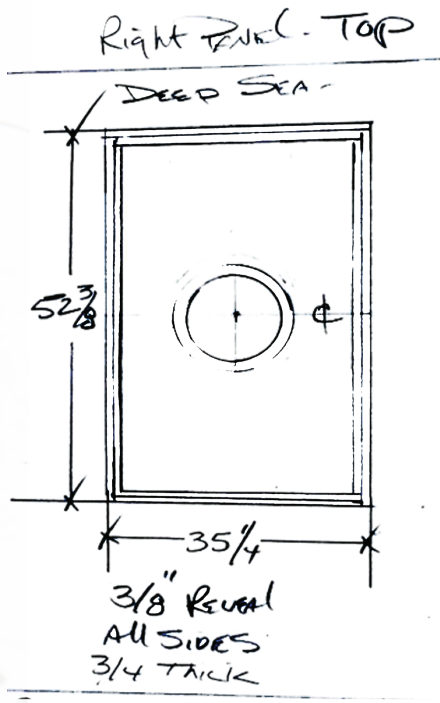

SKETCH

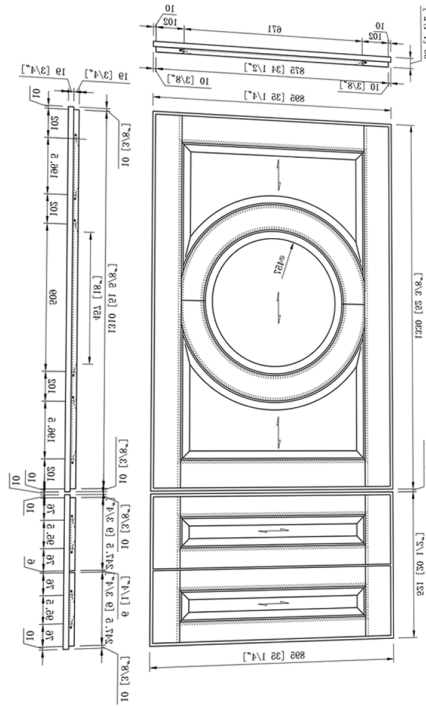

CREATE



REALITY

CUSTOM  
CAPABILITES

Craft + Main Cabinetry is fully customizable. From custom panels, to completely unique islands, we can create anything you can imagine. We have the capabilities to make your dream kitchen come to life.

# CONSTRUCTION

At Craft + Main Cabinetry, we offer three different construction options so that you can choose one that best suits your needs.

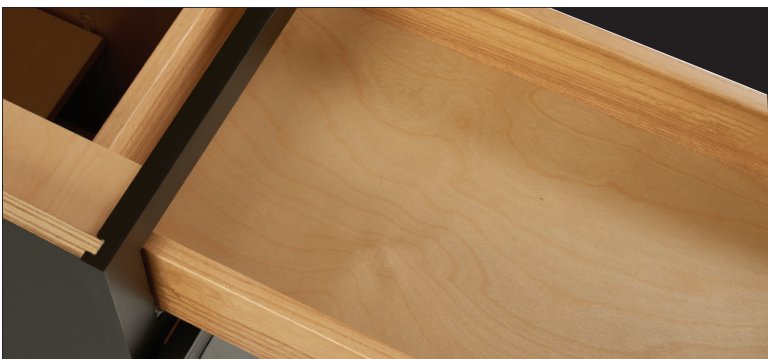

ULTIMATE	PREMIUM	ESSENTIAL	
✓	✓	✓	3/4" PLYWOOD ENDS
✓	✓		ALL PLYWOOD CONSTRUCTION
✓	✓		BLUM® SOFT CLOSE HINGE
✓			BLUM® TANDEM +BLUMOTION FULL EXTENSION
	✓	✓	BLUM® TANDEM +BLUMOTION 7/8" EXTENSION
✓			3/4" DOVETAIL DRAWER BOX
	✓	✓	5/8" DOVETAIL DRAWER BOX
✓			13" DEEP WALL CABINET
	✓	✓	12" DEEP WALL CABINET
✓	✓	✓	3/4" PLYWOOD SHELVES
✓	✓	WALL CAB ONLY	FULL DEPTH SHELVES
		✓	HALF DEPTH SHELVES
✓	✓	✓	I-BEAM CONSTRUCTION





# CRAFT + MAIN

## CABINETS

[craftandmaincabinetry.com](http://craftandmaincabinetry.com)

Please Note: Our product photography has been reproduced as accurately as printing technologies permit. To ensure the highest satisfaction possible, we strongly recommend you view an actual sample for best color, wood grain and finish representation.

CB-24PG-BROC-2201-V1

© 2022 FGI Industries, Ltd.  
Craft + Main Cabinetry and logo design  
are registered trademarks of FGI Industries, Ltd.